



Lykomitros

STEEL Constructions

steel S.A

A reliable trusted partner

LYKOMITROS STEEL S.A. is a trusted member of the steel constructions world market, with a total Facilities Covered Area of 42.000m².

We implement demanding projects:

- **Oil & Gas.** Onshore – Offshore Platforms, Desert Rigs, Masts, Substructures
- **Civil Engineering:** Buildings, Airport Facilities, Sports Facilities, Stadiums, Shopping Malls, Hospitals, Logistic Centers, Parking Facilities & Special Projects
- **Infrastructure:** Road –Railway bridges
- **Energy:** Power Plants, Oil & Gas Projects
- **Waste Management Plants**
- **Industrial:** Material Handling (Conveyors), Gantry Crane, Gantry Bridges, Cranes, Jib Cranes
- **Stainless Steel Constructions :** Tanks
- **Defense and Military:** Military equipment, Logistics, Hangars, Special structures for Military vehicles





Volos: a historic industrial town

Our factory is situated in the outskirts of Volos, Greece.

The strategic location of our facilities enables us to provide high quality logistic services. The distances from our factory, are **9 km from the Port of Volos** and **12 km from the airport**, while road transport (national highway) is 1km away.

The city of Volos combines the allure of the sea with mystical mountain charm - it is a coastal port city in Thessaly situated midway on the Greek mainland, about 326 km north of Athens and 215 km south of Thessaloniki. With population of 150,000 Volos is an important industrial center, while its port –Greece's 3rd largest- provides a bridge between Europe, the Middle East and Asia.

Proven track record of on-time and within the budget projects

LYKOMITROS STEEL- founded in 2006- is continuously expanding, implementing numerous projects in the domestic and global market.

We collaborate with some of the biggest construction companies globally and about 80 to 90% of turnover comes from export activity.

Our company delivers with the highest quality standards: we are a customer-oriented organization placing satisfaction at the core of our business decisions and project making.

Quality Assurance - C.E.

Certified excellence with: ISO 9001:2015, EN1090-2, ISO 3834-2, ISO 14001, OHSAS 18001, DNV GL 2.7-1

LYKOMITROS STEEL S.A.

CERTIFICATE

Management system as per
ISO 9001 : 2015
Quality Management Systems-Requirements
 In accordance with TÜV HELLAS (TÜV NORD) S.A. procedures, it is hereby certified that:

LYKOMITROS STEEL S.A.
 Ano Sparta, Sessio Magnisia
 385 00 Volos
 Hellas



applies a management system in line with the above standard for the following scope:

Fabrication and Installation of Steel Constructions.

Certificate Registration No. 841 18 0151
 Audit Report No. 6-2007-01-08

Valid from: 2016-03-08
 Valid until: 2019-03-07
 Valid certificate: 2016

TÜV HELLAS (TÜV NORD) S.A. Certification Body

Athens, 2016-05-15

This certificate was issued in accordance with the TÜV HELLAS (TÜV NORD) S.A. auditing and certification procedures and is subject to regular surveillance audits.



TÜV HELLAS S.A. 262, Mespelung Ave., 355 62 Chelagov, Athens, Greece

CERTIFICATE OF CONFORMITY OF THE FACTORY

PRODUCTION CONTROL
 Nr.: 0054-CPR-01350

In compliance with Regulation (EU) 883/2014 of the European Parliament and of the Council of 9 May 2014 on Construction Products Regulation (CPR), the certificate applies to the construction product:

Structural steel components up to execution class EXC4 acc. to EN 1090-2, declaration method 3a table A.1 of EN 1090-1 as per Annex which is integral part of this certificate

placed on the market under the name of:
LYKOMITROS STEEL S.A.
Ano Sparta
385 00, Sessio Magnisia, Greece
 and produced in the manufacturing plant:
LYKOMITROS STEEL S.A.
Ano Sparta
385 00, Sessio Magnisia, Greece

This certificate attests that all information concerning the assessment and verification of conformity of performance is recorded in Annex A.1 of the standard:
EN 1090-1:2009+A1:2011

under system 2+ see annex and that
the factory production control is assessed to be in conformity with the applicable requirements

This certificate will be valid until 28.08.2022 as long as neither the functional standard, the construction product, the assessment and verification of conformity of performance (AVCP) method nor the manufacturing conditions in the plant are not essential significantly, and the certificate has not been withdrawn or withdrawn by the factory production control certification body.

Date: 27.08.2017



ANNEX OF CERTIFICATE OF CONFORMITY OF THE FACTORY

PRODUCTION CONTROL
 Nr.: 0054-CPR-01350 dated 27.08.2017

WELDING CERTIFICATE

According to EN 1090-1, table B.1, the following data form a Welding Certificate which is an Annex to Certificate of Conformity of the Factory Production Control 0054-CPR-01350:

placed on the market under the name of:
LYKOMITROS STEEL S.A.
Ano Sparta
385 00, Sessio Magnisia, Greece
 and produced in the manufacturing plant:
LYKOMITROS STEEL S.A.
Ano Sparta
385 00, Sessio Magnisia, Greece
 EN 1090-2:2009+A1:2011
 Up to EXC 4 according to EN 1090-2:2009+A1:2011
 111, 121, 123, 130, 132, 133, 134, 135, 136, 137, 138, 139, 140, 141, 142, 143, 144, 145, 146, 147, 148, 149, 150, 151, 152, 153, 154, 155, 156, 157, 158, 159, 160, 161, 162, 163, 164, 165, 166, 167, 168, 169, 170, 171, 172, 173, 174, 175, 176, 177, 178, 179, 180, 181, 182, 183, 184, 185, 186, 187, 188, 189, 190, 191, 192, 193, 194, 195, 196, 197, 198, 199, 200, 201, 202, 203, 204, 205, 206, 207, 208, 209, 210, 211, 212, 213, 214, 215, 216, 217, 218, 219, 220, 221, 222, 223, 224, 225, 226, 227, 228, 229, 230, 231, 232, 233, 234, 235, 236, 237, 238, 239, 240, 241, 242, 243, 244, 245, 246, 247, 248, 249, 250, 251, 252, 253, 254, 255, 256, 257, 258, 259, 260, 261, 262, 263, 264, 265, 266, 267, 268, 269, 270, 271, 272, 273, 274, 275, 276, 277, 278, 279, 280, 281, 282, 283, 284, 285, 286, 287, 288, 289, 290, 291, 292, 293, 294, 295, 296, 297, 298, 299, 300, 301, 302, 303, 304, 305, 306, 307, 308, 309, 310, 311, 312, 313, 314, 315, 316, 317, 318, 319, 320, 321, 322, 323, 324, 325, 326, 327, 328, 329, 330, 331, 332, 333, 334, 335, 336, 337, 338, 339, 340, 341, 342, 343, 344, 345, 346, 347, 348, 349, 350, 351, 352, 353, 354, 355, 356, 357, 358, 359, 360, 361, 362, 363, 364, 365, 366, 367, 368, 369, 370, 371, 372, 373, 374, 375, 376, 377, 378, 379, 380, 381, 382, 383, 384, 385, 386, 387, 388, 389, 390, 391, 392, 393, 394, 395, 396, 397, 398, 399, 400, 401, 402, 403, 404, 405, 406, 407, 408, 409, 410, 411, 412, 413, 414, 415, 416, 417, 418, 419, 420, 421, 422, 423, 424, 425, 426, 427, 428, 429, 430, 431, 432, 433, 434, 435, 436, 437, 438, 439, 440, 441, 442, 443, 444, 445, 446, 447, 448, 449, 450, 451, 452, 453, 454, 455, 456, 457, 458, 459, 460, 461, 462, 463, 464, 465, 466, 467, 468, 469, 470, 471, 472, 473, 474, 475, 476, 477, 478, 479, 480, 481, 482, 483, 484, 485, 486, 487, 488, 489, 490, 491, 492, 493, 494, 495, 496, 497, 498, 499, 500, 501, 502, 503, 504, 505, 506, 507, 508, 509, 510, 511, 512, 513, 514, 515, 516, 517, 518, 519, 520, 521, 522, 523, 524, 525, 526, 527, 528, 529, 530, 531, 532, 533, 534, 535, 536, 537, 538, 539, 540, 541, 542, 543, 544, 545, 546, 547, 548, 549, 550, 551, 552, 553, 554, 555, 556, 557, 558, 559, 560, 561, 562, 563, 564, 565, 566, 567, 568, 569, 570, 571, 572, 573, 574, 575, 576, 577, 578, 579, 580, 581, 582, 583, 584, 585, 586, 587, 588, 589, 590, 591, 592, 593, 594, 595, 596, 597, 598, 599, 600, 601, 602, 603, 604, 605, 606, 607, 608, 609, 610, 611, 612, 613, 614, 615, 616, 617, 618, 619, 620, 621, 622, 623, 624, 625, 626, 627, 628, 629, 630, 631, 632, 633, 634, 635, 636, 637, 638, 639, 640, 641, 642, 643, 644, 645, 646, 647, 648, 649, 650, 651, 652, 653, 654, 655, 656, 657, 658, 659, 660, 661, 662, 663, 664, 665, 666, 667, 668, 669, 670, 671, 672, 673, 674, 675, 676, 677, 678, 679, 680, 681, 682, 683, 684, 685, 686, 687, 688, 689, 690, 691, 692, 693, 694, 695, 696, 697, 698, 699, 700, 701, 702, 703, 704, 705, 706, 707, 708, 709, 710, 711, 712, 713, 714, 715, 716, 717, 718, 719, 720, 721, 722, 723, 724, 725, 726, 727, 728, 729, 730, 731, 732, 733, 734, 735, 736, 737, 738, 739, 740, 741, 742, 743, 744, 745, 746, 747, 748, 749, 750, 751, 752, 753, 754, 755, 756, 757, 758, 759, 760, 761, 762, 763, 764, 765, 766, 767, 768, 769, 770, 771, 772, 773, 774, 775, 776, 777, 778, 779, 780, 781, 782, 783, 784, 785, 786, 787, 788, 789, 790, 791, 792, 793, 794, 795, 796, 797, 798, 799, 800, 801, 802, 803, 804, 805, 806, 807, 808, 809, 810, 811, 812, 813, 814, 815, 816, 817, 818, 819, 820, 821, 822, 823, 824, 825, 826, 827, 828, 829, 830, 831, 832, 833, 834, 835, 836, 837, 838, 839, 840, 841, 842, 843, 844, 845, 846, 847, 848, 849, 850, 851, 852, 853, 854, 855, 856, 857, 858, 859, 860, 861, 862, 863, 864, 865, 866, 867, 868, 869, 870, 871, 872, 873, 874, 875, 876, 877, 878, 879, 880, 881, 882, 883, 884, 885, 886, 887, 888, 889, 890, 891, 892, 893, 894, 895, 896, 897, 898, 899, 900, 901, 902, 903, 904, 905, 906, 907, 908, 909, 910, 911, 912, 913, 914, 915, 916, 917, 918, 919, 920, 921, 922, 923, 924, 925, 926, 927, 928, 929, 930, 931, 932, 933, 934, 935, 936, 937, 938, 939, 940, 941, 942, 943, 944, 945, 946, 947, 948, 949, 950, 951, 952, 953, 954, 955, 956, 957, 958, 959, 960, 961, 962, 963, 964, 965, 966, 967, 968, 969, 970, 971, 972, 973, 974, 975, 976, 977, 978, 979, 980, 981, 982, 983, 984, 985, 986, 987, 988, 989, 990, 991, 992, 993, 994, 995, 996, 997, 998, 999, 1000

Date: 27.08.2017



- **ISO 9001:2015:** Quality Management Systems – Fabrication & Installation of Steel Structures.

THE INTERNATIONAL CERTIFICATION NETWORK

CERTIFICATE

IQNet and its parties hereby certify that the organization

LYKOMITROS STEEL S.A.
 ANO SPARTIA, GR-385 00 SESSIO MAGNISIA, GREECE

for the following field of activities
FABRICATION AND INSTALLATION OF STEEL CONSTRUCTIONS
 has implemented and maintains a
Management System
 which fulfils the requirements of the following standard
ELOT 1801:2008

Issued on: 2016-08-08
 Validity date: 2019-08-08
 Registration Number: GR-0523-GA-G-140716

Michael Drechsel
 President of IQNet

G. Adonidis
 Director
 MIRTEC S.A.

ME

- **EN 1090-1-2:** EXC 4 (Execution class up to 4), **quality level prerequisite for C.E.**, of steel structures and aluminum structures

CERTIFICATE OF CONFORMITY OF MANAGEMENT SYSTEM

No of Certificate: **QA-C-1809/16**

BETAM S.A. certifies that the Health & Safety Management System of the company:

LYKOMITROS STEEL S.A.

is related to the following field(s) of activities:

FABRICATION AND INSTALLATION OF STEEL CONSTRUCTIONS

which is applied to its premises at:

ANOSPARTIA, GR-385 00 SESSIO MAGNISIA, GREECE

has been evaluated during an audit performed on the 04th, 05th & 05th of August 2016 and was found to conform to the requirements of the standard:

ELOT 1801:2008
OHSAS 18001:2007

This Certificate is issued according to the General Regulation for the Certification of MS of BETAM S.A. and is governed by the terms of the relevant contract, between LYKOMITROS S.A. and the company.

Period of validity: from 08 August 2016 to 08 August 2019

Volos, 08 August 2016
 For BETAM S.A.
 G. Adonidis
 Director

Volos, 03 August 2017
 For BETAM S.A.
 G. Adonidis
 Director

GR-QHS/2016/01/16/0001

- **ISO 3834-2:** Quality requirements for fusion welding of metallic materials.

TYPE APPROVAL CERTIFICATE

Certificate No.: **TAS00013R**
 Revision No.: **1**

This is to certify:
That the Offshore Container:
 with type designation(s): **Waste Sup**
 Issued to: **Lykomitros Steel S.A.**
 Volos, Greece

is found to comply with:
DNV 2.7-1 Offshore Containers (2013)
EN 12079 Offshore Containers-Design, construction, testing, inspection and marking
IMO/MSC Circular 860

Application 1
 Product(s) approved by this certificate is/are accepted for installation on all vessels classed by DNV GL.

Max. gross mass (kg)	6200
Max. payload (kg)	5000
Max. stowage height (m)	4.7
Enhancement factor	1.746

Issued by Aberdeen on 2017-07-03
 This Certificate is valid until 2021-07-02.
 1100161100130010 Aberdeen Verification - Offshore Equipment & Structures

Approved Engineer: **Andreas Lange**

For DNV GL
 Alex Dalg
 Head of Section

- **OHSAS 18001:** Health and Safety Management System
- **ISO 14001:** Environment Management System
- **DNV GL 2.7-1:** Offshore containers



The above picture regards Project SEM in Cyprus – Fabrication, Transportation and Installation of Steel Roof and Arch

We honor our customer's trust by implementing projects without any discount on the quality standards.

- **Engineering - Design**
- **Fabrication**
- **Transportation**
- **Installation**

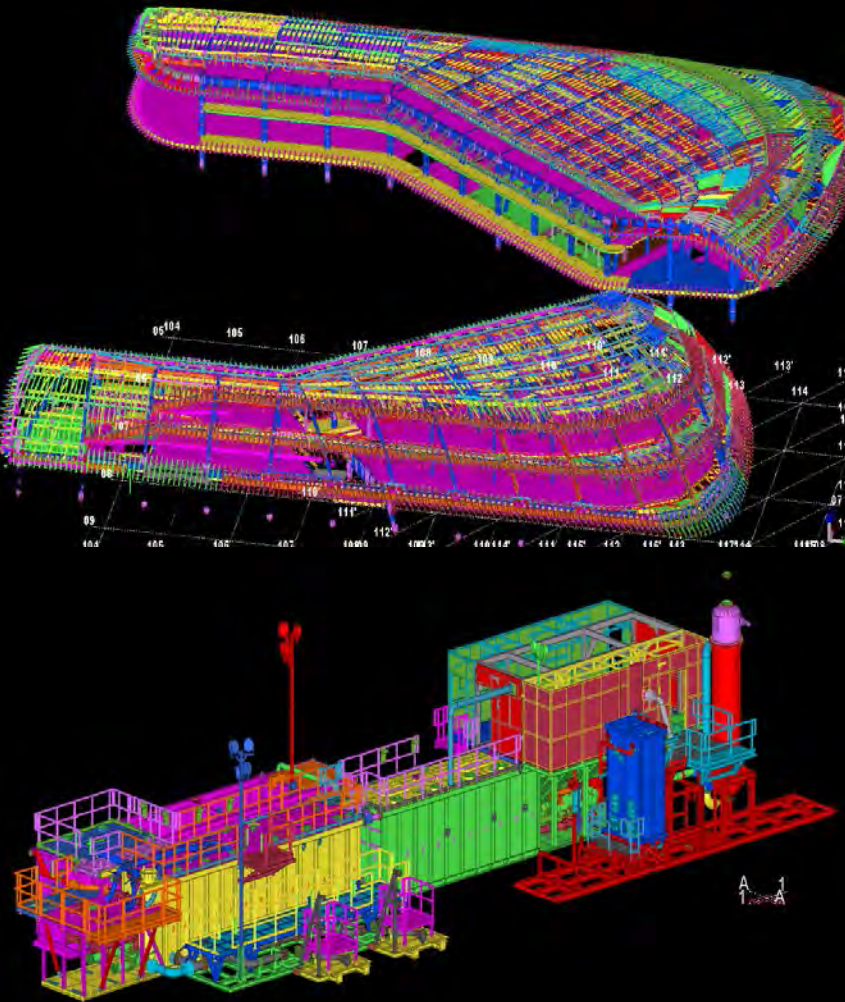

Engineering - Design



Design is performed by LYKOMITROS STEEL qualified & experienced designers using Software/Production TEKLA, CONSTRUSTEEL, ERP, BARCODE, ADVANCE, AUTODESK, INVENTOR, RHINO SAP, Epsilon Net, Columbus, Business Plus, SAP, RSTAB.

With TEKLA, Lykomitros Steel structural engineers are enabled to create accurately detailed, highly constructible 3D structural models - regardless of material or structural complexity as follows:

- Detail Design (static calculations)
- Design of bolt connections (nodes)
- Design 3-D model in Tekla software in order to prepare shop-installation drawings (BIM)

A complete package of all the structural drawings (as built) -including all details - is at the customer's disposal before and after the start of fabrication.

After the client's approval, the software provides Data output for CNC machines, thus eliminating human error during the industrialization of the project.



Fabrication

Our chartered engineers — with the overall supervision and coordination of the project - are specialized in building and bridge steel constructions.

Fabrication and welding is in accordance with the highest international standards and all phases are monitored by our established quality systems.

A quality plan is formed and it is submitted to the client for approval. During the programming of the material cutting and the assembly, dimensional tests take place.

Installation

The method of installation is studied and planned per project.

LYKOMITROS STEEL's installations are executed in a safe, economical and efficient manner.

Installation is performed by specialized skilled work force with all required mechanical means (cranes, aerial platforms etc.). Senior Lykomitros engineers supervise the whole process throughout. Lykomitros Steel S.A. preparing method statement for erection and a lifting plan of erection before the installation of the project.

Safety comes first!

Lykomitros Steel S.A. is certified for OHSAS 18001.

Throughout our experience, there are some general practices that have been proven sound over the years:

The structures must be planned to be unloaded and arranged close to erection points.

Cranes are only released when all connection bolts are inspected for their tightness.

All erector staff attends induction training prior to commencing work, where the supervisor engineer analyzes the project hazards and risks.

PPE equipment is provided and its use is compulsory. In case of required roofing works safety nets are installed.

A meeting is held at the start of every shift to analyze the work to be done, the hazards involved and the control measures in place to manage risks.

Our company applies a strict safety policy in the framework for in-factory as well as external work operations.

Lykomitros Steel S.A. has product and public liability insurances concerning all scope of works and cycle plant operations.

Construction Procedure with Monthly Production Capacity of 3000tns to deliver scale projects

LYKOMITROS STEEL maintains modern facilities, with a total area of 60,000 m² uncovered, and 13,500 m² covered. In 2018, LYKOMITROS STEEL acquired NEW additional facilities with 28.000 m² inside area and 70.000 m² total outside storage area.

The facilities include:

- Automatic shot blasting machine (pre-heating sand blasting - painting system) with width of 2.50 meters
- CNC Machines -- Robotic Machine
- Assembly – Welding
- Automatic shot blasting machine for READY HEAVY WELDED CONSTRUCTIONS with width of 4.50 meters and 4m Height
- Closed Painting area (Coating procedure) of 8000 m² area.
- Storage area of 12000 m² for ready-painted products
- Mock up area (pre assembly for domes, rigs and tank systems)



The Production Capacity is up to **3000 tons per month** in normal shift hours and the crane lift capacity per room is 150 tons.

The company's units use state-of-the-art equipment and follow the most advanced methods of quality control. We number **250 FTE employees** and from **50 up to 200 employees** at **any worksite**, aiming to reach 350 in the near future, of whom 40 are in management & administration and the rest work in production.

State of-the-art equipment



Function	Capability
2 Full Automatic closed Shot blasting machine	18 turbines for ready steel construction, with 4m height 4,5m width
CNC Cutting Corridor VB1050	Automatic cutting-piercing beams – automatic drilling carbide
Drilling System V630	Three separate controlled drilling units - Can be equipped with feeder rolls or feeder truck - Designed for big size fabricators
CNC Cutting Machine ESAB	Oxygen – Plasma cutting machine for plates up to 200 mm
Plate punching & Drilling System V250	V250 Plate punching machine
Punching & shearing System V550	Infeed system, suitable for flat and angle steel with a length up to 15m
Robotic Machine V808	Robotic thermal cutting machine equipped with the new faster and more accurate versatile Panasonic TL-1800G3 coping robot.
Cross-Section Beam Operator	Equipment for the construction of cross beams
Automatic Submerged Arc Welding Machine	Welds plates and tubes regardless of the quality of the material
Boring Machine	VEB UNION GERA, “FRITZ HECKERT” GBFKF150/1 Tischbohrwerk
Cylinder	BIKO 3-HCD
Bender-Pressing Machine-Pipping	Bending-Pressing and oxygen cutting machine
HACO Hydraulic Press Break	220t Press Break with useful load 3600m + 350tns HACO House
HACO Hydraulic Guillotine Shear	HACO Shear 12mm x 3000mm
Bevel Machine	Up to 100mm ±60° degrees and armoX plates
Lathe	TOS CELAKOVICE SN55
Cranes Bridges	ABUS: Lifting capacity: (8)3.2t-(3)10t-(4)20t-(5)32t.
Forklifts	COMBILIFT: Lifting capacity: up to 75tns

State of-the-art Equipment

Through the implementation of our current investment plan we have proceeded to plant infrastructure extension and machinery upgrade which further enhances our production capacities.

New Equipment Function	Capability
Remote control Telescopic Straddle Carrier (SC1260C) by Combilift	Handling of steel structures up to 70 tns-easy to loading and unloading trucks, saving significant amount of time.
Full Automatic closed Shot blasting machine for ready Welded Constructions	18 turbines for ready steel construction, with 4m height 4,5m width.
Robotic Machine V808, by Voortman	Plasma Hypertherm 400, and Oxygen, up to 100mm



Remote control Telescopic Straddle Carrier SC1260C by Combilift, handling steel structures up to 70tns

Welding boom in action performing welding operation on pipes with D1800 with 80 – 90 mm thickness for an Arch Bridge Project.

Robotic Machine V808, by Voortman, with Plasma Hypertherm 400 and Oxygen. Equipped with the new faster and more accurate versatile Panasonic TL-1800G3 coping robot.

We commit ourselves in the **design, fabrication and installation** of Projects in the fields of:

Bridges



Power Plants



Oil & Gas
Mud Tank
Systems



Desert Rigs
Onshore
Platforms



Fields of expertise

LYKOMITROS STEEL S.A.

We commit ourselves in the **design, fabrication and installation** of Projects
in the fields of:



Pipelines Modules



Offshore Platforms



Ductworks & Tanks





















Steel Glass Roofs

Multistorey
Buildings



WorldWide Projects

LYKOMITROS STEEL S.A.

Project Location		Customer	Description	Quantity (tons)
Germany - Algeria- Europe		Bentec GmbH	Onshore Platforms: Mud tank Farm Offshore Platforms	8.000
				
Oman-Europe		Bentec GmbH	Desert Rigs: Substructures	3.500
Greece		JV AKTOR-TERNA-J&P	Railway Arch Steel Bridge	10.000
Greece		Hellas Gold SA	Gold Mining Infrastructure	7.000
Germany		Contractor: Taim Weser: GmbH Owner: E.ON Kraftwerke GmbH	Fabrication of steel structures: Bridge Towers and Belt Conveyors	5.500
Syria		Metka SA	Design, Fabrication of Steel Structures: Gt Building	3.000
Algeria		SNG Sonal Gas-Metka SA	Design, Fabrication of Steel Structures: Gt Building, Main Pipe Rack	3.000
France		Se -Austria GmbH	Steel Roof For Shopping Center	2.000
Nigeria		Star Trading LTD	Design, Fabrication of steel structures: Buildings- Piper Racks	1.500
Ghana		Power Projects	Design, Fabrication of steel structures: Amandi project / ST Building – Feedwater Building – LSO External Pipeline - Pipe Racks	1.000
Greece		Vinci Constructions Grand Projects SAS	Designing, Fabrication and Erection: Double Span Steel Bridge 130 m	980
UK		Hitachi Zosen Inova AG	Static Calculation, Design, Fabrication of Steel Structures for Ferrybridge 2 project	900
Cyprus		Aumund	Design, Fabrication, Erection: Silo Bin – Silo Tower – Conveyors for Vassiliko Cement Plant	900
Azerbaijan		Nobel Oil	Tank System, Mast, Substructure	700
Azerbaijan		SOCAR-AQS	Design, Fabrication, Transportation: Waste Skips & Mud Cutting Boxes	700
Russia		FLS midth	Fabrication: Belt Conveyors	700
Qatar		JV: Aktor Sa/Al Darwish WLL/ Cimolai/Cybarco	New Doha International Airport/ Backup Approach and Training Centre	350
Jordan		Elemka SA	Pipe Rack: Designing, Fabrication	150

LYKOMITROS STEEL S.A. in "Inside Oil & Gas" Magazine

LYKOMITROS STEEL | PROFILE

LYKOMITROS STEEL | PROFILE

A TRUSTED STEEL PARTNER

Delivering steel projects for a host of end usages, including onshore and offshore drilling platforms, desert rigs, bridges, buildings and gantry cranes, Greece's Lykomitros Steel has built up a sturdy reputation in a relatively short period of time. Daniel Barnes reports.



Founded by Vasilios, Christos and Evangelos Lykomitros in 2006, Greek family firm Lykomitros Steel has spent the past 12 years making a name for itself as a special steel structures expert.

"We believe that Lykomitros Steel is a member of the steel construction work market that clients trust; we know our trust by implementing demanding projects without any reduction on the quality standards," states Vice President Christos Lykomitros. The company has delivered a variety of design, fabrication and installation projects across a range of industrial fields including energy (onshore and offshore platforms, desert rigs, power plants and mud tank systems), civil engineering, infrastructure and industrial (including bridges, steel glass roofs, ductworks and tanks, pipeline modules and multi-storey buildings).

Situated on the outskirts of the historic industrial town of Volos, just 9km from the Port of Volos and 12km from the airport, Lykomitros Steel's facilities span 15,000m² of covered workshops (plus a further 50,000m² of uncovered area), and include a range of technologically advanced, highly automated machinery.

On the basis of Lykomitros Steel's current investment plan, the company's facilities include a raft of state-of-the-art equipment. This includes an automatic robot blasting machine for ready welded construction, including overcoats, with a 4m height and 4.5m width for handling and blasting up to 80 tons of ready steel structures

and beams. In addition, CNC machines, oxygen and plasma cutting machines for plates up to 200mm, a 6-axis Automatic Welding Robot by Cloos, and a Remote Telescopic Straddle Carrier 801200 by Combilift, that can handle steel structures up to 70 tons, are all recent additions.

Lykomitros Steel's facilities also include a large closed painting area for the coating procedure, a storage area for ready-painted products, a jig-up and mock-up area for the pre-assembly of domes, rigs and tank systems. The production capacity is up to 1,000 tons per month in normal shift hours and this rate can be increased to 1,400 tons, as a result, the company has delivered numerous large scale and demanding projects and continues to do so.

But fabrication is only one of the company's four arms; the others being engineering, transportation and installation. As such, Lykomitros Steel's full-time team of 180 at its Volos facility are supplemented by a further 50 to 200 employees at any of its workites. Installation is performed by a skilled work force with all the required mechanical means and tools. Lykomitros engineers supervise the whole process throughout.

Featured with a comprehensive catalogue of industry specific certifications from the usual list of industry bodies - ISO, EN, OHSAS and ENY G - Lykomitros Steel formulates detailed quality plans for each project, signed off by the company's qualified and highly experienced quality department.

International acclaim

Despite the company's relative youth, it has a long list of projects - both underway and successfully completed - for projects dotted throughout Europe, the Middle East and beyond, with 80-90% of turnover originating from export activity.

In the oil and gas sector, Lykomitros Steel has enjoyed particular success working on projects for German drilling equipment producer, a jig-up and mock-up area for the pre-assembly of domes, rigs and tank systems.

"A very special oil and gas project for us was to deliver a mud tank farm for Sotef in Algeria and Czech Republic. The project consisted of the fabrication, special transportation and installation of 11 tanks that were between 70 and 90m in size, totalling 5,500 tons," said Mr Lykomitros.

"We also worked in Azerbaijan on a project for Bertec and SOCAR-ACS (the drilling company affiliated with Nobel Oil Services) involving an offshore platform rig up. Our scope of works consisted of the fabrication, special transportation and mock up installation on Lykomitros Steel facilities.

"Furthermore, we took great pride in the work we have done providing 70,000 tons of steel for a railway steel bridge in Dobruka, Greece, in a project headed by a joint venture between the three Greek construction companies AETOR, TEBKA and IAP," declared Christos Lykomitros. "Our scope of work in this project included engineering, fabrication, transportation and installation."

Another special project Mr Lykomitros highlighted, was the supply of 6,000 tons of steel to Syria and Algeria for Greek EPC, Infrastructure and defence company MEKA.

Strong values and supplier relations

Going back just a couple of years, to 2013-2014 to be precise, oil and gas projects accounted for approximately 80% of Lykomitros Steel's activity, a percentage which has now dropped to 30%. An effect of the global oil and gas downturn, this fall in oil and gas projects has resulted in the company applying its work in the other markets - its success in doing so, Christos Lykomitros credits to the company adhering to its own set of corporate values and the relationships the company has garnered with suppliers and customers alike.

"Our company's corporate values are: customer orientation, focus on detail, quality standards, respect of budget, delivery on time, added value services, trust and code of ethics for customer and suppliers," listed the vice president.

"As a global oriented company, we believe that ability is crucial to success. As for our reliability as a company, our company publishes its annual financial reports, which in 2017 revealed an annual turnover of €16 million."

Mr Lykomitros continues: "We have been working together for years with a plethora of suppliers and we have built a long-lasting

relationship of trust with them. Our suppliers are important to us as they help our company never make discounts on its quality and its credible results."

Continuing investment

In 2017, Lykomitros Steel initiated an investment plan that has already brought to fruition a plant infrastructure extension and machinery upgrades, further enhancing the company's production capacities. A Combilift remote control telescopic straddle carrier with a handling capacity of 60 tons was one of the key purchases of last year, as was the welding boom which can operate on pipes up to a thickness of 90mm.

"During 2018, our investment target is to complete a building that will be 30m in height and have a lifting capacity up to 200 tons in order for us to implement offshore-onshore full rig up platforms in our own facilities," revealed Mr Lykomitros.

Concluding, Mr Lykomitros painted a positive picture for the company's future, and who can blame him? With the milestones the company has already marked since its inception, Lykomitros Steel looks set to go from strength to strength.

"We are optimistic about the future. Through the years, the economy crashes and rises up again - so too does the oil price - and that is why we believe that it will rise up once more. That's why the always try to be competitive and not make discounts on the quality standards.

"Our vision is to keep developing and improving our market position by investing in human resources, equipment, research and development."



DNV-GL 2.1-F certified



1 Inside Oil & Gas

2 Inside Oil & Gas

3 Inside Oil & Gas

Lykomitros Steel S.A. with honor participated in "Inside Oil & Gas" Magazine and proudly stated the variety of design, fabrication and installation projects across a range of industrial fields, including Energy (Onshore and Offshore Platforms, Desert Rigs, Power Plants and Mud Tank Systems), Civil Engineering, Infrastructure and Industrial (Bridges, Steel Glass Roofs, Ductworks and Tanks, Pipeline Modules and Multi-Storey Buildings), that has successfully delivered.

Off Shore Platform Rig Up by Lykomitros Steel S.A. for BENTEC & Nobel Oil-SOCAR, Azerbaijan

LYKOMITROS STEEL S.A.



Off Shore Platform Rig Up, in Lykomitros Steel S.A. facilities

LYKOMITROS STEEL S.A.



Mock up installation in Lykomitros Steel S.A. facilities

Customer	BENTEC GmbH
Location	- Azerbaijan for SOCAR AQS
Quantity	150 tns
Technical Characteristics	-Mast System
Scope Of Works	-Fabrication -Special Transportation -Mock up installation on Lykomitros S.A. facilities



Mock up installation in Lykomitros Steel S.A. facilities

Customer	BENTEC GmbH
Location	- Algeria, Czech Republic , Europe, Poland
Quantity	- 20 sets of Mud Tank Farm - 8.000 tns
Technical Characteristics	- Onshore Platforms, 70 – 90 m ³ per tank
Scope Of Works	-Fabrication -Special Transportation -Mock up fully workable



Bentec GmbH | P.O. Box 1253 | 48443 Bad Bentheim

Lykomitros Steel S.A
Mr. Christos Lykomitros
Ano Spartia, Sesklo
Gr38500 Volos
Greece

From: Sebastian Fietz
Phone: +49 (0)59 22 72 681
Fax: +49 (0)59 22 72 527
E-Mail: Sebastian.Fietz @bentec.com
Date: 26/06/2018 Pages:

Letter of recommendation

Dear Mr. Lykomitros,

Please accept this letter as our personal and professional endorsement of Lykomitros Steel S.A as an outstanding business partner to Bentec GmbH.

Bentec is one of the leading manufacturers of drilling rigs and oilfield equipment worldwide based on more than 125 years history and vast experience.

Lykomitros Steel S.A. is our supplier for steel structure construction.

Since 2015 they also handle projects with installation of the electric parts, cabling of steel structure construction, installation of lamps and electrical equipment.

We have found a company to be world class in many ways. Their representation has always been fair, courteous and above all, professional in every respect.

Lykomitros Steel S.A partnership with us is exemplary of the model to which we would like all suppliers to aspire.

Best Regards,

Bentec GmbH Drilling & Oilfield Systems
Purchasing & Supply Management

S. Fietz
Sebastian Fietz
Purchasing & Supply Manager

Bentec GmbH Drilling & Oilfield Systems
Eisenwerkstrasse 1
50600 Bad Bentheim
Germany

BENTEC GMBH - DRILLING & OILFIELD SYSTEMS

Victoria address:	Phone: +49 (0)59 22 72 80	Directors:	Registered office:	Deutsche Bank AG, Nordhorn	VAT no. DE 81123151
Deimannsstrasse 1	Fax: +49 (0)59 22 72 457	Dirk Schuba	Bad Bentheim HRB 130192	IBAN: DE 89 2627 0096 0670 6775 00	Tax no. 55/20001461
48-656 Bad Bentheim	Web: www.bentec.com	Arend Lodder	Trade register: Osnabrück	BIC: DEUT 33 267	SWIFT: DEUT 33 267

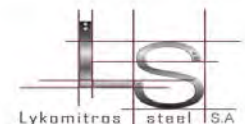

Mock up installation in Lykomitros Steel S.A. facilities



Mock up installation in Lykomitros Steel S.A. facilities

Customer	BENTEC GmbH
Location	- Ukraine
Quantity	- 5 sets
Technical Characteristics	- Mud Tank Farms, including Housing
Scope Of Works	<ul style="list-style-type: none">- Fabrication- Mock Up in Lykomitros Steel S.A. facilities- Utilization (Mechanical and Electrical equipment)



Mock up installation in Lykomitros Steel S.A. facilities



Oil & Gas Project: HALLIBURTON

LYKOMITROS STEEL S.A.

Customer	HALLIBURTON
Technical Characteristics	- 10 Units of 340 BBL Baraswift Storage Tanks
Scope Of Works	- Design - Fabrication - Mock Up in Lykomitros Steel S.A. facilities

HALLIBURTON

*Halliburton Mediterranean Limited
39-45 Evrosas Street
Arecippou, Larnaca 7100
Cyprus*

10/01/2019

Dear Sirs,

Letter of Recommendation

Please accept this letter as our endorsement of Lykomitros Steel as an outstanding business partner to our company.

The project of fabricating Baraswift tanks for our Liquid Mud Plant in Cyprus was executed in a very professional manner and we are keen to express our satisfaction at both the production quality and speed.

We look forward to working with you on future projects.

Yours sincerely,

Halliburton Mediterranean Ltd.



Offshore Containers: SOCAR - AQS

LYKOMITROS STEEL S.A.

Customer	SOCAR - AQS
Location	Azerbaijan
Quantity	400
Technical Characteristics	-Waste Skips -Mud Cutting Boxes
Scope Of Works	-Design -Fabrication -Transportation



Certified by DNV GL 2.7-1



Certified by DNV GL 2.7-1



Certified by DNV GL 2.7-1

TELESCOPIC JIB CRANE

of capacity 1.5t, 3.2t, 5t, 6.3t

LYKOMITROS STEEL S.A.

Description

Lykomitros Steel serves a broad range of customers with the construction and supply of Steel Cranes & Steel Telescopic Cranes. Lykomitros Steel S.A. qualified and experienced engineers have the expertise to *study, fabricate* and *supply* to customers high quality Steel Cranes with unique technical characteristics.

Basic Technical Characteristics

- Hoist & trolley electric operated
- Automatic reduction in lifting capacity: lift load at 10m – 3.2tns, lift load at 6m – 5.0tns
- Indoor or Outdoor crane adequacy
- Temperature range from -40°C up to +40°C
- Foundation/Counter Weight column



Bridge Project: JV AKTOR-TERNA-J&P

LYKOMITROS STEEL S.A.



J/V TITHOREA - DOMOKOS

Protocol no: TR-635/3168

Date: 01/08/2018

To:
LYKOMITROS STEEL S.A.
ANO SPARTIA
SESKLO VOLOY

PROJECT: «Remaining works for the completion of infrastructure and building facilities and construction of superstructure, e/m installations, signaling, telecommunications and electrification for the new Tithorea – Domokos dual high-speed rail line (C.N. 635)»

Subject: LETTER OF RECOMMENDATION

Dear Mr. Lykomitros,

Please accept this Letter as our personal and professional endorsement of Lykomitros Steel S.A. as a business partner (subcontractor) to J/V "TITHOREA-DOMOKOS".

J/V "TITHOREA-DOMOKOS" is a joint venture composed by the three leading construction companies in Greece, AKTOR S.A., TERNA S.A. and J&P-AVAX S.A., which in 2014 undertook the major project "Remaining works to complete the infrastructure and building facilities, and construction of the trackwork, electrical mechanical installations, signaling and telecommunications systems for the electrification of the new Tithorea - Domokos high-speed two-way railroad line".

Since August 2016, Lykomitros Steel S.A. is our supplier for steel structure construction of "Railway Bridge SG26" within the project, in Domokos, Greece. They have handled the fabrication of approximately 7.000 tons of steel.

Particularly, Lykomitros Steel S.A. supplied the arches of the bridge, consisting of pipes of Diameter Ø1800x80 and Ø1800x60, fabricated from carbon steel S355K2 quality. Moreover, they supplied 6 out of 12 end boxes of the deck (joint arch -deck, 110 tons each one) fabricated from carbon steel S355K2 quality and also fabricates the hangers of the Railway Bridge from Ø180 S355NL quality according to Exc4.

For the J/V

Spyros Karavakis
Project Director

Customer	JV AKTOR-TERNA- J&P
Location	Greece – Domokos Bridge
Quantity	10.000 tns
Technical Characteristics	-High Speed Railway Bridge -Cable suspended Arch -3 Main Span: 130m-160m
Scope Of Works	-Engineering -Fabrication -Transportation and Installation



Bridge Project: JV AKTOR-TERNA-J&P

LYKOMITROS STEEL S.A.



Transportation of the Bridge's Nodes of 110tns



Bridge Project: ELEMKA

LYKOMITROS STEEL S.A.

Customer	ELEMKA SA
Location	Greece - Ikonio
Quantity	1700 tns
Technical Characteristics	-High Speed Railway Bridge -Cable suspended Arch -Main Span: 120m
Scope Of Works	-Engineering -Fabrication -Transportation -Installation

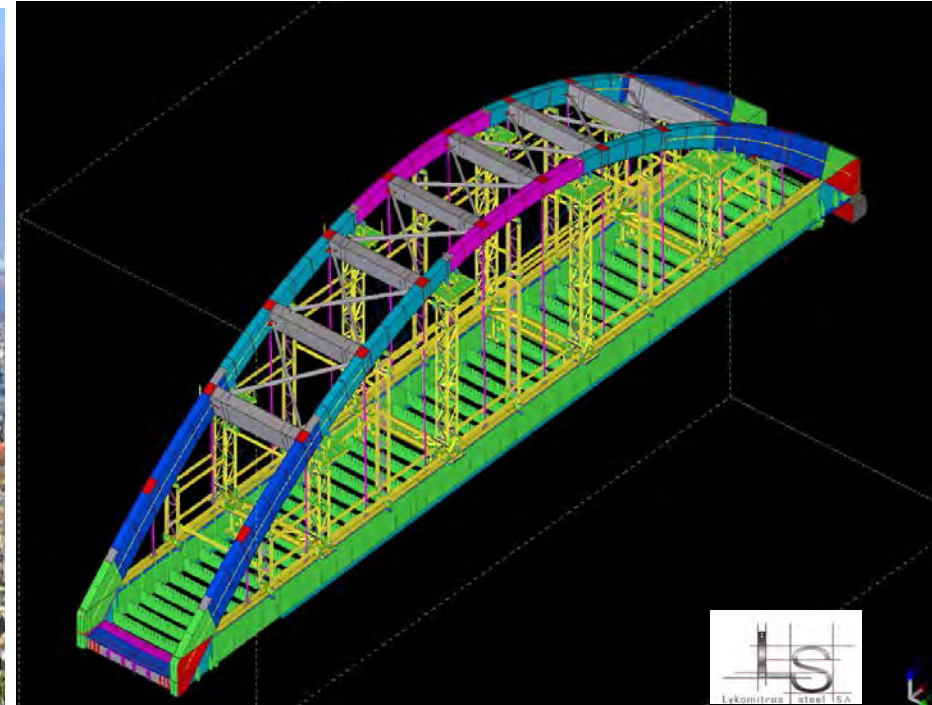



Case Stories

HEMPADUR FAST DRY 15560, HEMPADUR MASTIC 45880, HEMPATANE HS 55610

Ikonio Bridge

Hempel system provides bridge ISO 12944 protection

A 110-meter arch truss bridge on the railway connecting Greece's port of Piraeus with the new logistics centre at Thrisio Pedio was assembled 24 meters distant from where it belonged. It's not that the engineers got their measurements wrong. They had planned it that way.

The bridge, which is the longest of its type in Greece, is painted with a 5-coat system designed by Hempel to meet ISO 12944 requirements for category C5-I protection. It is comprised of **HEMPADUR FAST DRY 15560** (1 x 80 µm), **HEMPADUR MASTIC 45880** (2 x 80 µm), and **HEMPATANE HS 55610** (2 x 80 µm).

Erecting the bridge had to account for many factors, explains Athanasios Aronis, project manager at ELEMKA S.A., the general contractor. Among others, it had to consider the site's difficult accessibility and limitations on interrupting traffic on the under-passing road.

"The most convenient way to meet all the requirements," Mr. Aronis relates, "was to construct the bridge on a temporary site parallel to the crossing span so that once the bridge construction was completed it could be slid into its final position."

LYKOMITROS STEEL S.A. of Volos and **DS ISKRA SA.** of Kumanovo were subcontractors for steel fabrication. Completed in late 2009, the bridge was coated with about 6,500 litres of Hempel paints.



HEMPEL (UK) LTD.
Llantarnam Industrial Park
Gwent NP44 3XF Cwmbran
Tel: +44 (0)1633) 874024
Fax: +44 (0)1633) 489089
E-mail: sales.uk@hempel.com
www.hempel.co.uk

ELEMKA S.A.
TRADING AND CONSTRUCTION COMPANY

02/05/2011

To whom it may concern

CERTIFICATION OF WORKS

We certify that LYKOMITROS STEEL S.A. was assigned to fabricate and successfully executed, according to the technical specifications, the steel structure of the railway bridge in Ikonio-Athens. The total amount of the works was 2.300.000 €.

For ELEMKA S.A.

ELEMKA
TECHNICAL, CONSTRUCTION
TOURISTIC & TRADING S.A.
8, ARTEMIDOS Str. • 15125 MAROUSI ATHENS
GREECE
TEL: +30-210-6117000 FAX: +30-210-2710362
VAT: EL 094280568

LS
Lykomitros | steel S.A.

8, Artemidos St., 151 25 Marousi , Greece • TEL: +30-210 - 811.7000 • FAX: + 30-210-27.10.362
<http://www.elemka.gr>, E-mail: info@elemka.gr

Bridge Project: VINCI CONSTRUCTIONS

LYKOMITROS STEEL S.A.

Customer	VINCI CONSTRUCTIONS GRANDS PROJECTS SAS
Location	Greece – Kamares Bridge
Quantity	1000 tns
Technical Characteristics	-Double Span Bridge 130m
Scope Of Works	-Engineering & Design -Fabrication -Installation

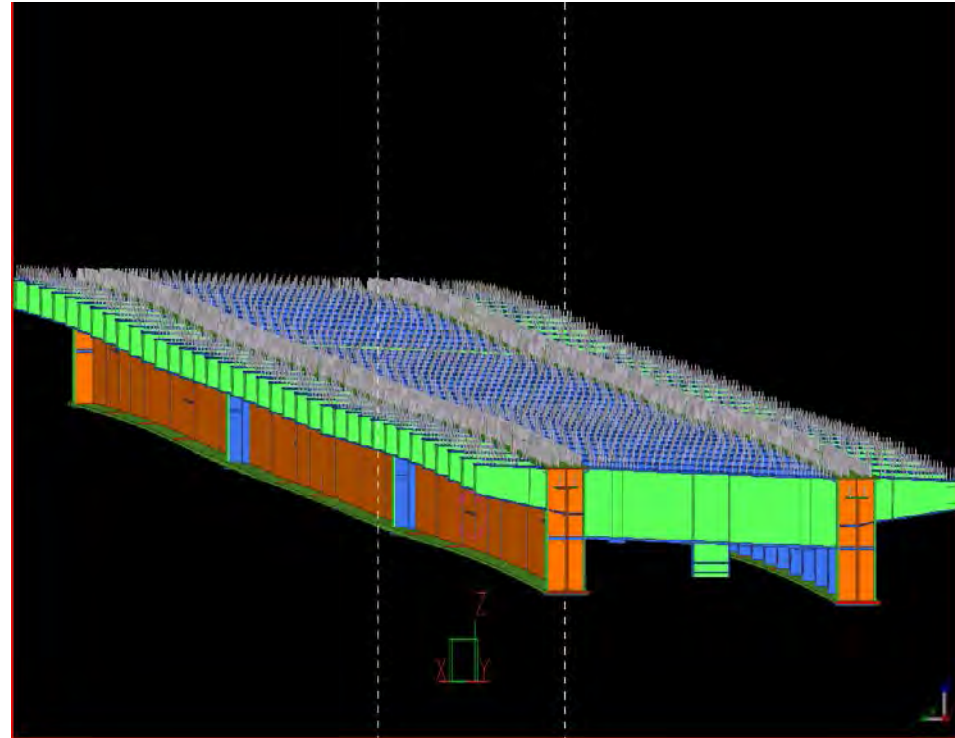



VINCI
CONSTRUCTION

GRANDS PROJETS

EKPPT Motorway Project

Drepano, 26th April 2011
Ref: TOE/JSC/ADO/SUB/L/2011/003574

To : **LYKOMITROS STEEL A.E.**
Ano Sparta, SESKLO VOLOU, P.O Box 38500, GREECE
Tel. 24210 96739 / Fax. 24210 96729
Attn. Mr LYKOMITROS Vassilis – C.E.O

Subject : Bridge composite deck-steel structure works reference

Dear Sir,

I hereafter confirm that Company LYKOMITROS STEEL A.E did execute for VCGP the factory fabrication of our "Kamareos" composite bridge full welded steel structure. The contract represented 500T of S355 steel with FCAW welding process with gas (n°136)

These steel works have been performed in 2010 with high respect of latest European standards, right in targeted schedule and contract price.

Assembled parts passed successfully the inspections of Bureau Veritas Greece, VCGP and SETEC Paris Experts.

I will not hesitate to tender again LYKOMITROS STEEL A.E. company for any similar project.

Yours sincerely,
VCGP

JS CLOITRE
Site Manager

Internal Distribution.....P. MORAND, Project Manager

Page 1 / 1

Vinci Construction Grands Projets
Drepano, Rion – 26504 RION, PATRAS
☎ 2610 961 200 * Fax. 2610 910 365

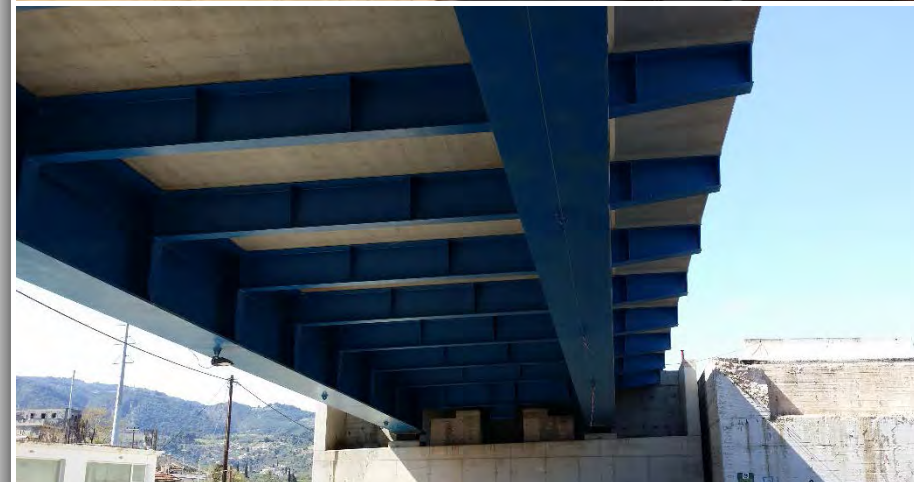

Steel Glass Roof: SEELE

LYKOMITROS STEEL S.A.

Customer	SEELE
Location	France - Paris
Quantity	180000 different pieces
Technical Characteristics	-Les Halles Galvanised and Painting Steel Roofing -Secondary steel construction
Scope Of Works	-Design -Fabrication -Transportation



Main Train Station in Paris

LYKOMITROS STEEL S.A.





se-austria GmbH & Co. KG, Gewerbestraße 2, 4861 Schörfling, Austria

seele

Lykomitros Steel S. A.
Ano Spartia Sesklo
38500 Volos
Griechenland

E-mail
frank.kellermann@se-austria.com

Ext
549

My Ref./Date
KEF/2014-09-25

Dear Sir or Madam

Secondary Steel quality received from Lykomitros

We herewith can confirm quality of secondary steel structure received from supplier Lykomitros was satisfactory.

Yours faithfully

For and on behalf of
se-austria GmbH & Co. KG
Schörfling

Frank Kellermann
Project Manager

se-austria GmbH & Co. KG
Gewerbestraße 2, 4861 Schörfling
Austria

LG Wels, Reg.-No.: FN 192526 b
Jurisdiction Wels, Austria
VAT-No.: ATU 486 53 808

Personally liable partner:
se-austria GmbH
LG Wels, Reg.-No.: FN 92038 x

Managing Directors:
Ing. Hannes Mairbauer
Dipl.-Ing. (FH) Thomas Spitzer

Certified EN ISO 9001,
EN ISO 14001, OHSAS 18001

Phone: +43 7662 22000 - 0
Fax: +43 7662 22000 - 400

office@se-austria.com
www.seele.com

Customer	SEELE
Location	England - London
Quantity	30 tns
Technical Characteristics	-Tottenham Court Road Station Upgrade Entrance
Scope Of Works	-Design -Fabrication



Customer	SEELE
Location	England - London
Quantity	100 tns and 40 tns respectively
Technical Characteristics	-Brook Green Steel Roofing -Victoria Gate Leeds
Scope Of Works	-Design -Fabrication



Brook Green London



Victoria Gate Leeds

se-austria GmbH & Co. KG, Gewerbepark 2, 4861 Schörfling, Austria

seele

Lykomitros Steel S. A.
c/o Christos Lykomitros
Ano Spartia Sesklo Magnesia
GR 38500 Volos

Email
office@se-austria.com

My Ref./Date
prg/2019-01-21

Letter of Recommendation

To whom it may concern,

This is to certify that Lykomitros Steel S.A is one of the preferred steel suppliers for se-austria GmbH & Co. KG, a company of the seele group.

We are working with Lykomitros Steel S.A. since 2013 and would like to especially highlight their involvement in manufacturing the steel constructions for the following projects:

- Brook Green, London/UK, completion 2015: approx. 2,700sqm steel-glass roof; 40 to. steel construction
- Victoria Gate Arcades, Leeds/UK, completion 2016: approx. 2,100sqm atrium roof; 40 to. steel construction

Both projects were completed on time and to a very high standard of quality. We are happy to recommend Lykomitros Steel S.A as a dependable and quality-driven expert. If you have any questions, please feel free to contact us.

Yours faithfully

se-austria GmbH & Co. KG
Schörfling

Simone Staufer
Head of Procurement

se-austria GmbH & Co. KG
Gewerbepark 2, 4861 Schörfling,
Austria

LG Wels, Reg.-No.: FN 192526 b
Jurisdiction Wels, Austria
VAT-No.: ATU 486 53 808

Personally liable partner:
se-austria GmbH
LG Wels, Reg.-No.: FN 93038 x

Managing Directors:
Ing. Juergen Laky, MBA
Dipl.-Ing. (FH) Thomas Spitzer

Certified EN ISO 9001,
EN ISO 14001, OHSAS 18001

Phone: +43 7662 22000 - 0
Fax: +43 7662 22000 - 400

office@se-austria.com
www.seele.com

Waste Plant: Ferrybridge 2

Customer	Hitachi Zosen Inova AG
Location	UK
Quantity	900 tns
Technical Characteristics	-Steel structures for waste plant
Scope Of Works	-Static Calculations -Design -Fabrication

REFERENCE

To whom it may concern:

Zurich-based Hitachi Zosen Inova (HZI) is a global leader in energy from waste (EfW), operating as part of the Hitachi Zosen Corporation Group. HZI acts as engineering, procurement and construction (EPC) contractor and project developer delivering complete turnkey plants and system solutions for thermal and biological EfW recovery.

See also: www.hz-inova.com & www.hitachizosen.co.jp/english/index.html

The present Reference is issued upon the request of Lykomitros Steel S.A. to confirm that Lykomitros Steel S.A. has delivered steel structure to the following operating plant:

Ferrybridge 2 (UK):

Ferrybridge Multifuel 2 is a state of the art Energy from Waste Incineration Plant consisting of 2 incinerations lines. This engineering plant will have a generating capacity of circa 90MW, enough energy to power around 160,000 homes.

Lykomitros Steel S.A. delivered approximately 720 tonnes of S235 steel, bolts, platforms, ladders, plates, cladding and railings for the Flue Gas Treatment (FGT) system of Ferrybridge 2. The FGT system is located outdoors and so the Steel Structure was delivered with corrosive protection category C4. The scope of supply for the FGT system included:

- The structural steelwork for the Filter and Reactor, including the penthouses on top of the Filters
- The structural steelwork for the Staircases
- The structural steelwork for the Silos

We are satisfied with the quality of the steel structure supplied by Lykomitros Steel S.A. as well as with the performance of Lykomitros Steel S.A. and would gladly work with Lykomitros S.A. again.

Hitachi Zosen Inova, on its behalf as a Purchasing Party, gives its positive feedback in regards to delivered steel structure and its referral to other potential clients of Lykomitros Steel S.A.

Date: Zurich 09.01.2019



Laurence Shargool
Technical Project Manager

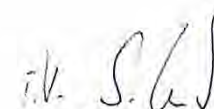

Susanne Greb
Project Procurement Manager



Anaerobic Digestion (AD) Plant: Epirus

LYKOMITROS STEEL S.A.

Customer	Hitachi Zosen Inova AG
Location	- Epirus, Greece
Technical Characteristics	-Two Kompogas® Steel Digesters PF1500 -Shafts, Steel Housing, Tightness Units, Gearboxes and Bearings, Gate Valves, Insulation & Housing, Piping & Equipment, Electrical Cabling Works (Turnkey Project).
Scope Of Works	-Fabrication -Transportation -Installation



To whom it may concern

Hitachi Zosen Inova AG
Hardturmstrasse 127
P. O. Box 680
8037 Zurich
Switzerland

Dieter Zaugg
SSC-SM / Procurement Manager AD
Phone +41 44 277 15 68

Dieter.Zaugg@hz-inova.com

www.hz-inova.com

20 December 2018

Letter of Recommendation

Hitachi Zosen Inova is pleased to recommend Lykomitros Steel S.A. registered in 38500 Volos (GR) as a reliable and professional partner in the construction industry and we confirm that this company has duly completed the AD (anaerobic digestion) project P-3316 Epirus, Greece.

The scope consisted of the following:

- Manufacturing and Installation of two complete steel digesters, including but not limited to manufacturing, surface treatment, inspections, packaging, transportation, unloading, erection and tightness testing.
- Manufacturing and erection of steel structure, including but not limited to manufacturing, surface treatment, inspections, packaging, transportation, unloading and erection.
- Manufacturing and Installation of Insulation and housing, including but not limited to manufacturing, packaging, transportation, unloading and installation.
- Manufacturing and Installation of general piping, including but not limited to supplying, unloading, installation and pressure testing.
- Manufacturing and Installation of cable installation, including but not limited to supplying, unloading, installation (pulling, terminating) and signal testing.

The project was carried out between 16.11.2017 and 03.10.2018.

Currently the commissioning phase is ongoing, when mechanical or electrical support is needed, flexible on demand support is provided by Lykomitros.

The project was carried out in a professional way in respect of the required deadlines to the satisfaction of any parties engaged in the project.

Especially we would like to point out the cooperative culture of Lykomitros. The availability and engagement of the whole team was excellent. With many years of experience in steel structure fabrication and erection, Lykomitros pro-actively proposed improvements to ease

and shorten the fabrication and erection time. During the erection works their whole team was very committed to finish the job on time; even during severe weather conditions solutions were found.

The high quality performance provided by the contractor combined with good cooperation places this company within our valuable and prospective partners for future projects.

Yours sincerely
Hitachi Zosen Inova AG

Rebecca Räss
Head of Project Execution AD

Dieter Zaugg
Procurement Manager



Steel façade for glass: Berlin

LYKOMITROS STEEL S.A.

Customer	GIG FASSADEN
Location	- Berlin, Germany
Technical Characteristics	- Steel façade for glass
Scope Of Works	- Design - Fabrication - Mock Up in Lykomitros Steel facilities - Installation



Upgrade of Jet A1 Fuel Tanks: Malta

LYKOMITROS STEEL S.A.

Customer	Chemie-Tech Malta Limited
Location	- Malta International Airport
Technical Characteristics	-Jet A1 Fuel Tanks
Scope Of Works	-Design -Fabrication -Transportation



Silo Tower – Silo Bin Conveyors

Customer	AUMUND
Location	Cyprus – Vassiliko Cement Plant
Quantity	900 tns, 150m Height
Technical Characteristics	-Silo Bin – Silo Tower Conveyors
Scope Of Works	-Design -Fabrication -Installation



Letter of Recommendation

Dear Mr. Lykomitros,

Please accept this letter as our personal and professional endorsement of Lykomitros Steel S.A as an outstanding business partner to Vassiliko Cement Works Ltd (VCW).

Vassiliko Cement Works Ltd was established in 1963 and is one of the largest heavy industries in Cyprus producing Cement and Clinker.

Since beginning of 2017 Lykomitros Steel S.A is our supplier for steel structure construction for our facilities expansion project as subcontractor to AUMUND Fördertechnik GmbH which halted the engineering of this project and directly to VCW for the Installation of Steel Structures and mechanical equipment of approximately 1430 tons.

They halted the following project "Fabrication and Erection of Silo Tower and Bin and Conveyor Bridges, Housing and Hopper steel structures (950 tons), Installation of Mechanical equipment conveyor belts, ducts and machinery (480 tons)" for VCW in Cyprus:

We have found a company to be world class in many ways. Their representation has always been appropriate and always according to the agreed time schedules, courteous and above all, professional in every aspect, with excellent quality of fabricated structures and on-time delivery.

Lykomitros Steel S.A partnership with us is exemplary. Is the model to which we would like all suppliers to be inspired.

Best Regards,



Christoforos Nicolaides

New Projects & Investments Manager

Tel. (+357) 24 845 555

Office. (+357) 24 845 531

Cell. (+357) 99494812

Fax: (+357) 24 332 651

Email: chr.nicolaides@vassiliko.com

Web: www.vassiliko.com



| Vassiliko Cement Works Public Company Ltd

| Post: P.O. Box 22281, CY-1519, Nicosia, Cyprus



Board of Directors:
A. Antoniou – Executive Chairman
G. St. Galatariotis
C. St. Galatariotis
St. G. Galatariotis
C. Koutsos
Ch. Panayiotou
M. Mansi Montenegro
A. Mikelides
Chr. Ailouchery
A. Katsifos
S. S. Anastasiades



Steel Glass Roof: SEM

LYKOMITROS STEEL S.A.

Customer	MD Structure
Location	Cyprus
Quantity	200 tns
Technical Characteristics	SEM Dome and Arch Structure
Scope Of Works	-Design, Fabrication, Transportation, Installation

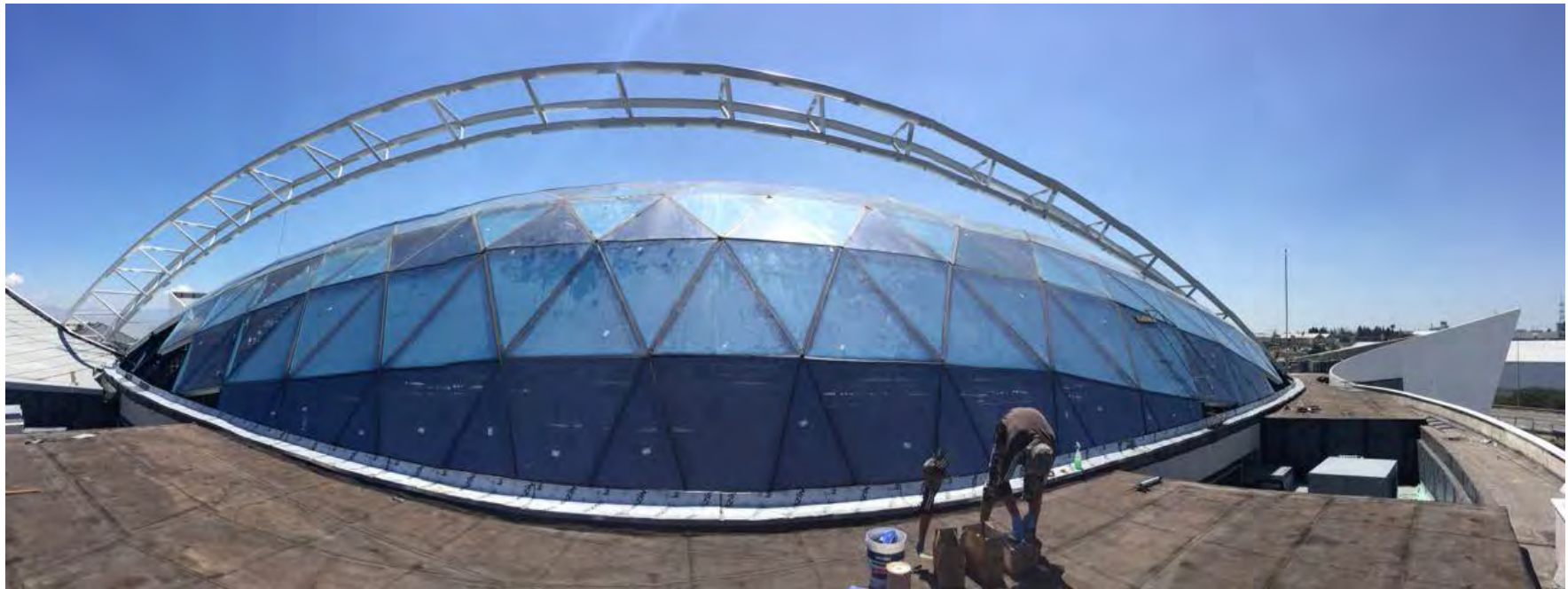

Multistorey Building: Oval Tower

LYKOMITROS STEEL S.A.

Customer	Cybarco
Location	Limassol, Cyprus
Tower Height	+100m
Technical Characteristics	Oval Tower
Scope Of Works	-Design -Fabrication -Transportation & Installation



Building Project: ADCC

LYKOMITROS STEEL S.A.

Customer	ADCC
Location	Qatar – Doha
Quantity	350 tns
Technical Characteristics	-New Doha International Airport
Scope Of Works	-Design & Engineering -Fabrication -Transportation & Installation



Power Plant Project: EON

LYKOMITROS STEEL S.A.

Customer	Owner: EON Contractor : TAIM WESER GmbH
Location	Germany - Datteln
Quantity	5.500 tns
Technical Characteristics	-Bridge - Towers & Belt Conveyors
Scope Of Works	-Design -Fabrication- Transportation



Power Plant Project: EON

LYKOMITROS STEEL S.A.

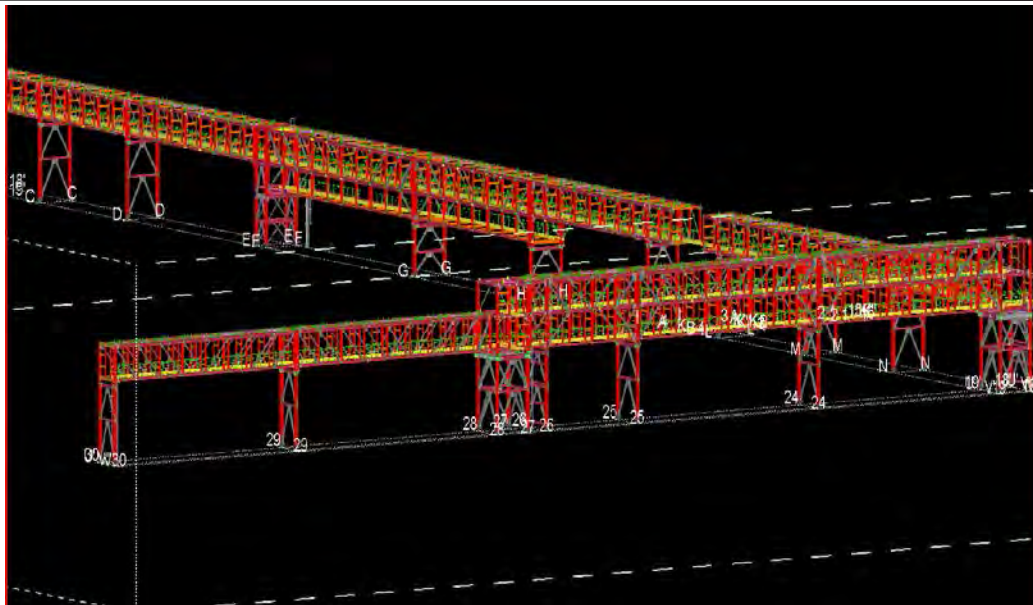

Your reference:
Our reference: FKO/AEM
Direct Line: -19
Bad Oeynhausen, 02.03.2011

Lykomitros-Steel S.A.
Ano Spartia – Sesklo Magnisia
Mr. Christos Lykomitros
Volos – Greece P.C. 38003

Delivery release of steel structure for E.ON

Dear Sir,

We certify that LYKOMITROS-Steel S.A. is assigned to fabricate steel structures for buildings and galleries for E.ON Kraftwerke GmbH, Coal Energy Power Plant "Datteln" in Germany.

The total project budget is up to 7.000.000 € and LYKOMITROS S.A. has already delivered 5.000.000 € production. All deliveries checked by SLV-Duisburg are within the required specification.

Yours faithfully
TAIM WESER GmbH

ppa. Dirk Speckmann

General Manager

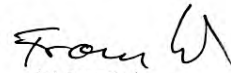

i.V. Franz Koch

Project Manager



Power Plant Project: METKA SA

LYKOMITROS STEEL S.A.



Customer	ELEMKA SA (METKA GROUP)
Locations	Syria- Deir Ali, Algeria- Hassi R'Mel
Quantities	3.000 tns , 3.000 tns per project respectively
Technical Characteristics	-GT Building, Main Pipe Rack, Gas Receiving Station Building & Electrical Control Building, Water Pretreatment Building, Formworks
Scope Of Works	-Design -Fabrication

TO WHOM IT MAY CONCERN

13/02/2012

CERTIFICATION OF WORKS

We certify that LYKOMITROS STEEL S.A. was assigned at 15/01/2011 to fabricate steel constructions for the DEIR ALI II - power plant in Syria.

All deliveries have been checked and were within the required technical specification.

The delivered total weight counted up to **3000tns**.



Anestis Chatzipanagiotidis
General Manager

8, ARTEMIDOS ST., 151 25, MAROUSI, GREECE • TEL.: +30-210-61.17.000 • FAX: +30-210-27.10.362
http://www.elemka.gr, E-mail: info@elemka.gr



Boiler Structures : METKA SA

LYKOMITROS STEEL S.A.

Customer	Public Power Corporation of Greece
Locations	Aghios Dimitrios Power Plant, Greece
Quantities	800 tns
Technical Characteristics	Upgrade of Boiler Structures for the Power Plant of Aghios Dimitrios (Units 1 &2) Hardface material EIPA 480 - pulverized fuel ducts
Scope Of Works	-Design -Fabrication

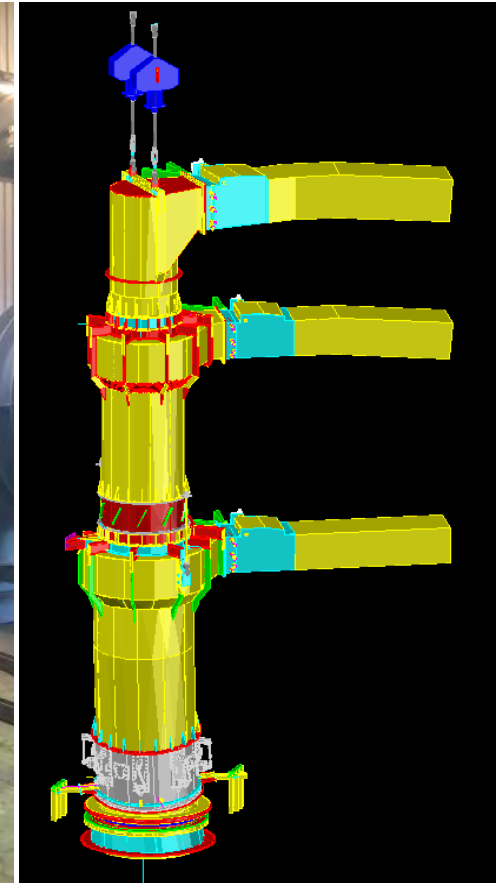



To whom it may concern

Athens, 27.07.2018

Letter of recommendation

This is to confirm that the company **Lykomitros Steel S.A.** is a supplier of **MYTILINEOS S.A. - Group of Companies** for the fabrication of steel structures.

More specifically, **Lykomitros Steel S.A.** and within the below projects, has delivered successfully steel structures as follows:

- The fabrication of GT Building, platforms and pipe racks with total weight of 2.700tns for the DEIR ALI II - Combined Cycle Power Plant project in Syria.
- The fabrication of GT Building, platforms and pipe racks with total weight 2.300tns for the HASSI R'MELL I - Open Cycle Power Plant project in Algeria.
- The fabrication of ST Building, Water Treatment Building, Feedwater Building, Switchyard Structures Workshop & Storage Building, platforms and pipe racks with total weight 1.500tns for the Amandi Combined Cycle Power Plant project in Takoradi, Ghana

- The fabrication of the Air Ducts and the heating lances made of 1.4835 inox material and Pulverized Fuel Ducts with hardfaced materials as well as the dampers and other mechanical components of approximately 1.000tns for the project of Ag. Dimitrios SES, Unit I&II: Boilers retrofit for NOx reduction with primary measures.

We are pleased to recommend Lykomitros Steel S.A. on the basis of its successful performance.

Yours sincerely,
For Mytilineos S.A. - METKA BU EPC



Customer	Hellas Gold SA
Locations	Skouries, Northern Greece for final client Hellas Gold SA
Quantities	7.000 tns
Technical Characteristics	Flotation Building, Re grind Building, Pebble Crusher Building, Air Blowers Building, Re-Agent Storage, Platforms, Pipe Racks, Plant Workshop
Scope Of Works	-Design, Engineering -Fabrication -Transportation, Installation





FIELD ENGINEERING, PROCUREMENT OF MATERIALS AND
CONSTRUCTION WORKS FOR SKOURIES PROJECT.

05.07.2016

CERTIFICATION OF GOOD PERFORMANCE

It is hereby confirmed that with the Contract awarded to **LYKOMITROS S.A** since 5th of February 2015 for **"SUPPLY, FABRICATION, AND ERECTION OF THE STEELWORK FOR S-4001 FLOTATION / REGRINDING / FILTRATION & STOCKPILE BUILDING"** at **SKOURIES** project in **GREECE** the company **LYKOMITROS S.A** executed **4.500.000 kg (4.500 tons)** of steelwork fabrication during a period of **6 months (February 2015 – September 2015)**.

All works were provided with excellent quality, on time delivery and in a professional manner to our satisfaction.

Yours Sincerely
AKTOR S.A.
25 ERMOULI STR. | 145 64 KIFFISSIA-ATHINA-GREECE
TEL: +30 210 8184000 | FAX: +30 210 8184903

For Aktor S.A

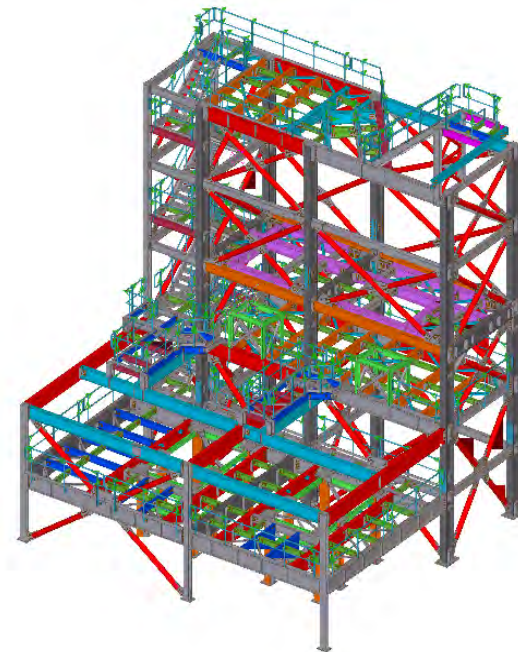
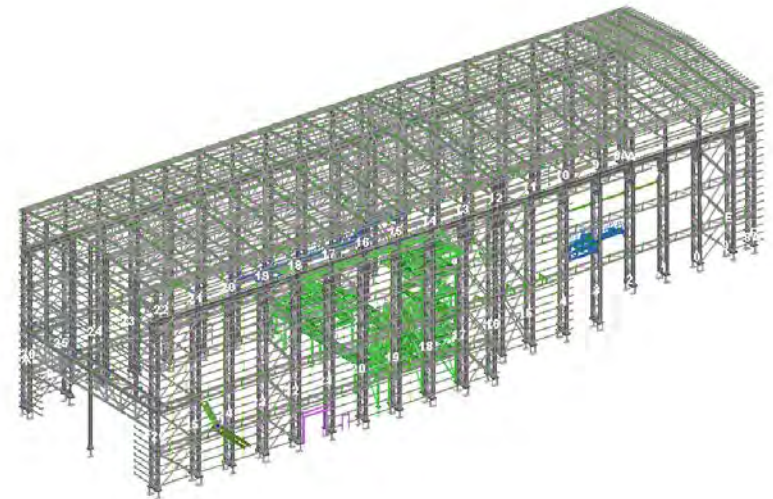

Mining Infrastructure: Hellas Gold SA

LYKOMITROS STEEL S.A.

Customer	Hellas Gold SA
Locations	Olympias Phase II Project, Northern Greece
Quantities	300 tns
Technical Characteristics	Chutes, Tanks, Pump Boxes, Duct Works
Scope Of Works	-Design, Engineering -Fabrication -Rubber Lining, Transportation, Installation



Friday, 3 March 2017

To whom it may concern

This letter recognizes Lykomitros Steel S.A. for their professionalism, support, dedication and timely delivery towards the fabrication and supply of structural steel and plate-work items for the **Olympias Phase II Project**.

The Olympias Phase II Project is the upgrade to a pre-existing mine owned and operated by Hellas Gold S.A. (a subsidiary of Eldorado Gold Corporation) and is located near coastal town of Olympiada, in the Halkidiki Peninsula of northern Greece.

For the Olympias Phase II Project Lykomitros Steel S.A. fabricated and supplied approximately **300 tonnes** of structural steel. For this project Lykomitros Steel S.A. also fabricated and supplied plate-work items, which included tanks, pump and discharge boxes, chutes and launders, and were fabricated from carbon or stainless steel. A portion of these plate-work items had rubber or polyethylene lining, or wear-plates affixed to them.

The work carried out by Lykomitros Steel S.A. on our project has been of excellent quality and I can recommend their services to others.

Robert Toet, PMP

Project Manager Olympias Phase II, Hellas Gold/Eldorado Gold



Friday, 3 March 2017

To whom it may concern

This letter recognizes Lykomitros Steel S.A. for their professionalism, support, dedication and timely delivery towards the fabrication and supply of structural steel for the **Skouries Project**.

The Skouries Project is a new development by Hellas Gold S.A. (a subsidiary of Eldorado Gold Corporation) for the mining of high-grade gold-copper porphyry deposit located in the Halkidiki Peninsula of northern Greece.

For the Skouries Project Lykomitros Steel S.A. fabricated and supplied approximately **300 tonnes** of structural steel.

The work carried out by Lykomitros Steel S.A. on our project has been of excellent quality and I can recommend their services to others.

Robert Toet, PMP

Projects Engineering Manager Greece, Hellas Gold/Eldorado Gold

Mining Infrastructure: Hellas Gold SA

LYKOMITROS STEEL S.A.

Chutes, Tanks, Pump Boxes, Duct Works

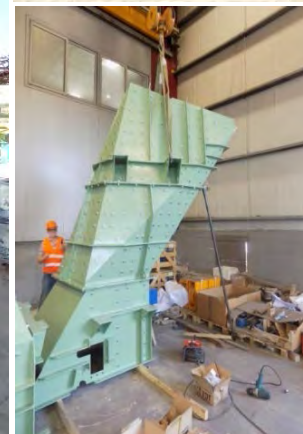

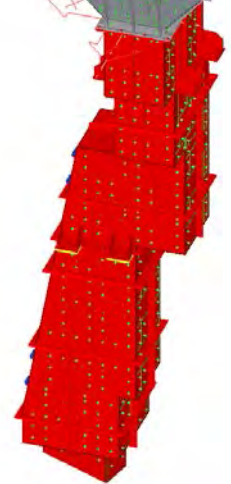
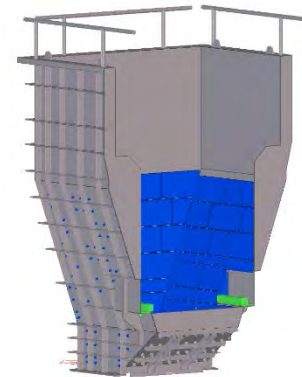
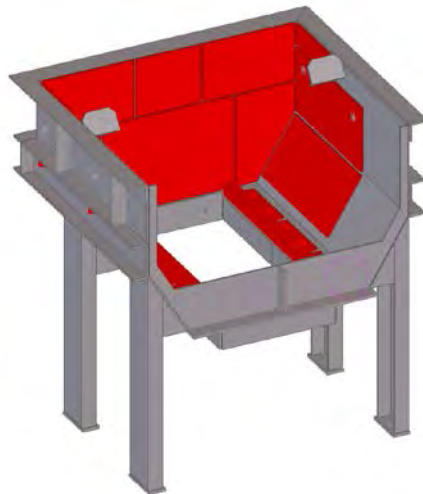
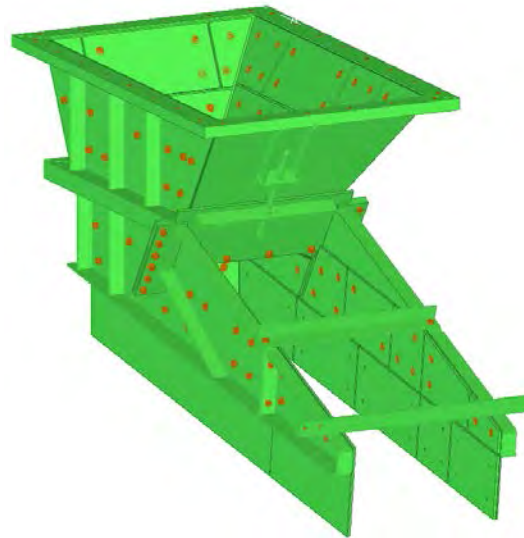
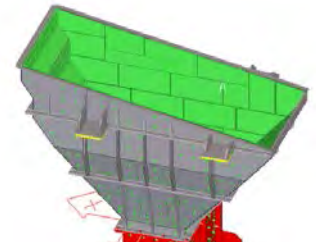
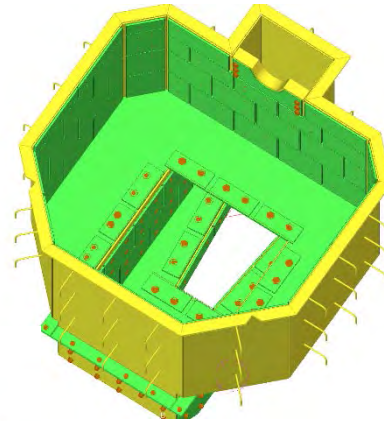
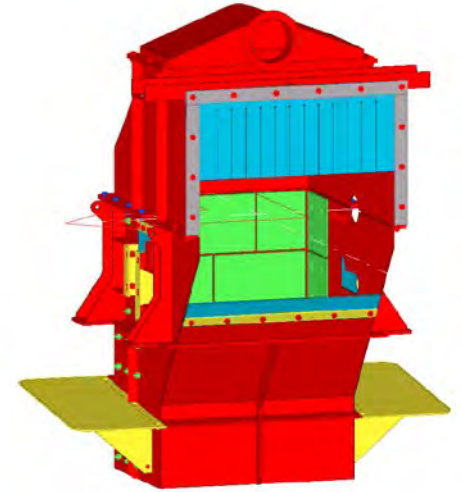
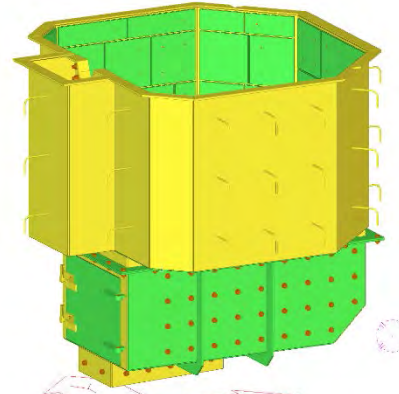
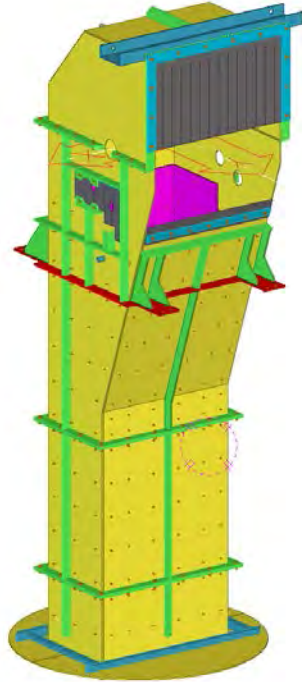
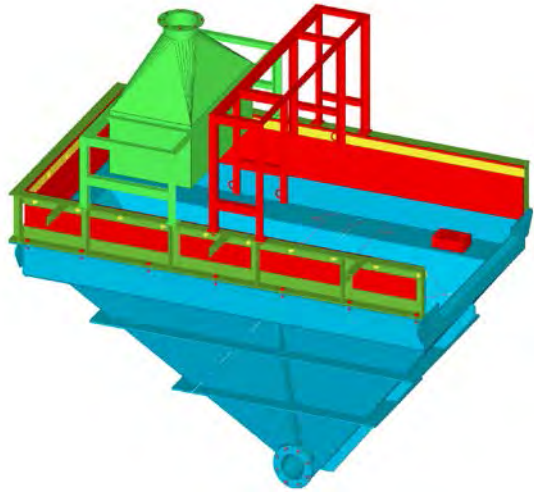

Silo for Food - Duct Work

LYKOMITROS STEEL S.A.

STAR TRADING COMPANY Ltd

Location	-Nigeria
Quantity	2000 tns
Technical Characteristics	-Buildings and Silo for food
Scope Of Works	-Fabrication

STAR TRADING COMPANY LIMITED

TRUST COMPANY COMPLEX, AJELTAKE ROAD, AJELTAKE ISLAND
MAJURO MH96960, MARSHALL ISLANDS
REGISTRATION NUMBER: 57073

Letter of Recommendation

Dear Mr. Lykomitros,

Please accept this letter as our personal and professional endorsement of Lykomitros Steel S.A as an outstanding business partner to Star Trading Company Limited – Marshall Islands.

Since 2012, Lykomitros Steel S.A. is one of our suppliers for steel structure construction. They successfully handled the following and demanding projects:

- Rom Oil Mills Limited, Ibadan, Nigeria, Prj Name: Steel Structure for Pipe Rack – **Phase I** (ML-12020ZB8).
- Rom Oil Mills Limited, Ibadan, Nigeria, Prj Name: Steel Structure for Pipe Rack – **Phase II** (ML-12020ZB8).
- Golden Sugar Company Limited, Apapa, Lagos, Nigeria, Prj Name: Steel Structure for Sugar Building No.6
- Rom Oil Mills Limited, Ibadan, Nigeria, Prj Name: Additional Steel Structure for Pipe Rack – **Phase III** (ML-12020ZB8).

We have found a company to be world class in many ways. Their representation has always been fair, courteous and above all, professional in every respect.

Lykomitros Steel S.A partnership with us is exemplary of the model to which we would like all suppliers to aspire.

Best Regards

13 December 2018

STAR TRADING COMPANY LTD
TRUST COMPANY COMPLEX
AJELTAKE ROAD, AJELTAKE ISLAND
MAJURO, MARSHALL ISLANDS
Ioannis Vlasopoulos
Secretary/Treasurer/Director



Packing and Storage

For the packing:

- Chocks and packaging corners are placed between the structures in order to eliminate collision
- The structures are wrapped with protective cell air
- Metallic galvanized special strips are covering the package



Storage,
ready package
for loading

All Types of Transport

LYKOMITROS STEEL S.A.

Oversized
Transport



Trucks



Vessel and
Containers
(High Cube
and Open Top)



Container



Partnerships with the best

We work closely with our global partners, to understand unique project needs and develop tailored proposals to specific market demands.

Our global network is supported by some of the biggest construction companies: abroad, among others, we have implemented projects with BENTEC GmbH, SEELE, HITACHI ZOSEN INOVA, HALLIBURTON, FLSMIDTH, AKTOR, METKA, GIG FASSADEN, CYBARCO, also, VINCI CONSTRUCTION, HELLAS GOLD S.A., VASSILIKO CEMENT, NOBEL-OIL & BUGGING - UDDEMANN.

Our partners are key to our development and success - working together we create value and provide end-user customers with highly competitive solutions.



